

CAT: FEET:

TYPE: PROJECT:

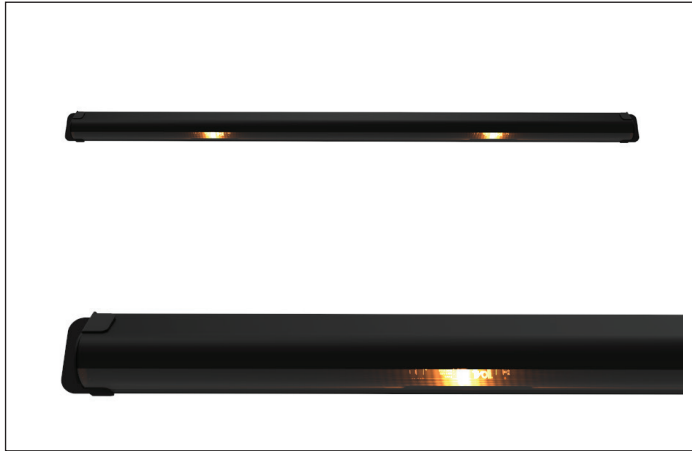

Features

- Compact (1¼" x 7/8"), visible light source tamper-resistant linear LED lighting system
- Optically clear polycarbonate co-extruded directional lens features 45° lighting cut-off angle to illuminate pathway and delineate wall simultaneously
- Base and lens available 4' and 8' field cuttable lengths
- End-to-end continuous mounting with continuous through wires minimize voltage drop
- Use with Tivoli's patented two-tone bullnose stair nosing with reflective edge step delineation

Mounting

Designed for aisle walls and staircases with 18' minimum bend radius. Suggested mounting height above floor is 10" for 36" wide step, 11" for 48" step, 12" for 60" step and 13" for more than 60" step.

Applications

Ideal for wall mounted aisle and step lighting applications.

Warranty
5 years



Technical Information

6" OC				
LED Color	1900K - 4000K	Red	Blue	Amber
*Lumens/ft	9		N/A	
*Watts/ft	0.34	0.58	0.96	0.8
*Lumen/Watt	26		N/A	
Max Run Length	100'	70'	55'	55'

12" OC				
LED Color	1900K - 4000K	Red	Blue	Amber
*Lumens/ft	4.5		N/A	
*Watts/ft	0.17	0.29	0.48	0.4
*Lumen/Watt	26		N/A	
Max Run Length	120'	80'	55'	55'

CRI	>80/TYP83
Kelvin Temp	1900K, 2700K, 3000K, 3500K, 4000K (+/-80K) 3SDCM, Red, Blue, Amber
Rated Life	75,000 hrs.
Order Increments	8' Sections
Operating Voltage	12V DC
Power Supply	Class 2
Dimmable	Yes

*Based on 3000K Sample

Profile Dimensions

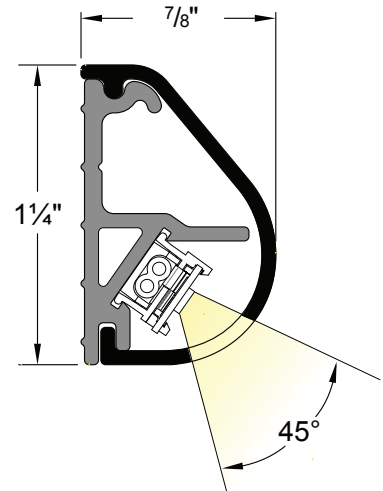



Recommended Power Supplies

ADUL - NON DIMMING

DESCRIPTION	CAT NO	APPLICATION	PRIMARY VOLTAGE	SECONDARY VOLTAGE	CIRCUIT BREAKERS	MAX LOAD	CIRCUIT CAPACITY
ADUL Series Class 2 Transformer	ADUL-80-1-5-12-D	Indoor / Damp	100-277V AC 5ø60 HZ	12V DC	1	60W	5A
	ADUL-150-2-5-12-D				2	2x60W	2x5A
	ADUL-240-3-5-12-D				3	3x60W	3x5A
	ADUL-320-4-5-12-D				4	4x60W	4x5A

ADUL - 0-10V DIMMING

DESCRIPTION	CAT NO	APPLICATION	PRIMARY VOLTAGE	SECONDARY VOLTAGE	CIRCUIT BREAKERS	MAX LOAD	CIRCUIT CAPACITY
ADUL Series Class 2 Transformer	ADUL-80-1-5-12-DOT	Indoor / Damp	100-277V AC 5ø60 HZ	12V DC	1	60W	5A
	ADUL-150-2-5-12-DOT				2	2x60W	2x5A
	ADUL-240-3-5-12-DOT				3	3x60W	3x5A
	ADUL-320-4-5-12-DOT				4	4x60W	4x5A

ADUL - DMX SINGLE ADDRESS

DESCRIPTION	CAT NO	APPLICATION	PRIMARY VOLTAGE	SECONDARY VOLTAGE	CIRCUIT BREAKERS	MAX LOAD	CIRCUIT CAPACITY
ADUL Series Class 2 Transformer	ADUL-80-1-5-12-DIN	Indoor / Damp	100-277V AC 5ø60 Hz	12V DC	1	60W	5A
	ADUL-150-2-5-12-DIN				2	2x60W	2x5A
	ADUL-240-3-5-12-DIN				3	3x60W	3x5A

ADUL - DMX MULTI ADDRESS

DESCRIPTION	CAT NO	APPLICATION	PRIMARY VOLTAGE	SECONDARY VOLTAGE	CIRCUIT BREAKERS	MAX LOAD	CIRCUIT CAPACITY
ADUL Series Class 2 Transformer	ADUL-150-2-5-12-DIN-2	Indoor / Damp	100-277V AC 5ø60 Hz	12V DC	2	2x60W	2x5A
	ADUL-240-3-5-12-DIN-3				3	3x60W	3x5A
	ADUL-320-4-5-12-DIN-4				4	4x60W	4x5A

INFINITY - MLV / ELV / 0-10V / PWM / TRIAC

DESCRIPTION	CAT NO	APPLICATION	PRIMARY VOLTAGE	SECONDARY VOLTAGE	CIRCUIT BREAKERS	MAX LOAD	MIN LOAD	CIRCUIT CAPACITY
Infinity Series Class 2 Transformer	INF-J-30-1-2.5-12	Indoor / Outdoor	100 - 277V AC	12VDC	1	30W	3W	2.5A
	INF-J-60-1-5-12				1	60W	6W	5A
	INF-J-180-3-5-12				3	3x60W	3x6W	3x5A
	INF-J-300-5-5-12				5	5x60W	5x6W	5x5A

Recommended Dimmers

DIMMING - 0-10V

DESCRIPTION	CAT NO	APPLICATION	INPUT VOLTAGE	OUTPUT VOLTAGE	MAX LOAD
0-10V Dimmer	DIM-LD-010	Indoor	12V/24V DC	12V/24V DC	30 mA max. output (sink only)

DIMMING - MLV

DESCRIPTION	CAT NO	APPLICATION	INPUT VOLTAGE	OUTPUT VOLTAGE	MAX LOAD
MLV Dimmer	N-600	Indoor	120V AC	120V AC	450W
	N-1000				800W
	N-1500				1200W
	D-600				450W
	M-600				450W
	M-1000				800W

DIMMING - ELV

DESCRIPTION	CAT NO	APPLICATION	INPUT VOLTAGE	OUTPUT VOLTAGE	MAX LOAD
ELV Dimmer	ME-600	Indoor	120V AC	120V AC	450W
	DE-300				300W

DIMMING - DMX

DESCRIPTION	CAT NO	APPLICATION	INPUT VOLTAGE	OUTPUT PROTOCOL	MAX UNIVERSE
DMX Controller	TVOQ-1-WH	Indoor	5V DC	DMX 512	1
	TVOQ-2-BK		6V DC		
	TVOQ-2-WH				
	TVOQ-10-BK-7				
	TVOQ-10-WH-7		6-7V DC		2



TVOQ-1-WH
WH (White only)

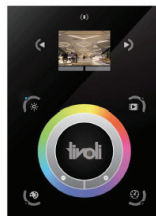

TVOQ-10-XX-7
XX = BK (Black), WH (White)



TVOQ-2-XX
XX = BK (Black), WH (White)

Ordering Information

PRODUCT CODE	PCB SPACING	LED BOTTOM	FINISH	FIXTURE LENGTH
UWTT			M	8.0
UWTT = Usher Wall Titanium	06 = 6" 12 = 12"	19 = 1900K 27 = 2700K 30 = 3000K 35 = 3500K 40 = 4000K AM = Amber RD = Red BL = Blue	M = Matte	8.0 = 8'

Mounting Accessories

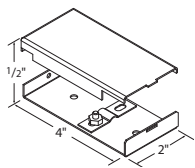

JBOX-LP
Junction box, low profile

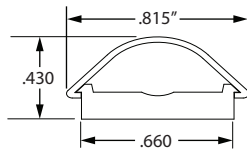

BS-CC-8
Wall wireway, 8' Black Base & Conduit Cover

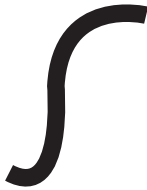

BSL-PC-1/4
1/4" Flex Conduit, Black

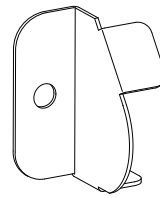

UTT-EC-L
Left End Cap (shown)
UTT-EC-R
Right End Cap



TM-2-3/8
Self tapping wall screw,
Phillips profile - 2 3/8" length

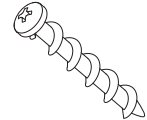

TM-1-1/2
Self tapping, deep cutting,
corkscrew-like thread,
Phillips profile - 1 1/2" length

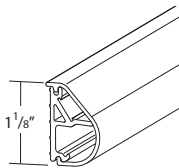

UWTT-LENS-M-8
Usher lens - 8'
WLS-BASE-8
Wall light system base - 8'

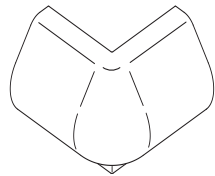

UWTT-O-CRNR
Usher outside corner joint, matte black

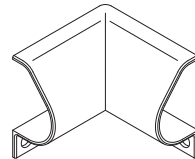

UWTT-I-CRNR
Usher inside corner joint, matte black

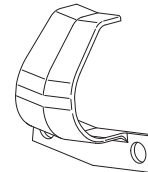

UWTT-U-JNT
Usher upward wall joint

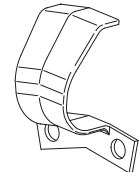

UWTT-D-JNT
Usher downward wall joint

Replacement Parts

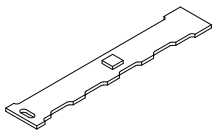

UTT-LED-19
1900K
UTT-LED-27
2700K
UTT-LED-30
3000K
UTT-LED-35
3500K
UTT-LED-40
4000K
UTT-LED-AM
Amber
UTT-LED-BL
Blue
UTT-LED-RD
Red

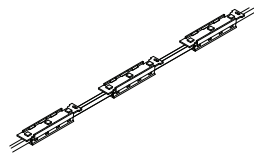

6" O.C. SPACING
UTT-06-STRAND-19
Replacement Strand With 1900K LED
UTT-06-STRAND-27
Replacement Strand With 2700K LED
UTT-06-STRAND-30
Replacement Strand With 3000K LED
UTT-06-STRAND-35
Replacement Strand With 3500K LED
UTT-06-STRAND-40
Replacement Strand With 4000K LED
UTT-06-STRAND-AM
Replacement Strand With Amber LED
UTT-06-STRAND-BL
Replacement Strand With Blue LED
UTT-06-STRAND-RD
Replacement Strand With Red LED

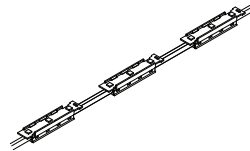

12" O.C. SPACING
UTT-12-STRAND-19
Replacement Strand With 1900K LED
UTT-12-STRAND-27
Replacement Strand With 2700K LED
UTT-12-STRAND-30
Replacement Strand With 3000K LED
UTT-12-STRAND-35
Replacement Strand With 3500K LED
UTT-12-STRAND-40
Replacement Strand With 4000K LED
UTT-12-STRAND-AM
Replacement Strand With Amber LED
UTT-12-STRAND-BL
Replacement Strand With Blue LED
UTT-12-STRAND-RD
Replacement Strand With Red LED

TwoTone Bullnose & Accessories

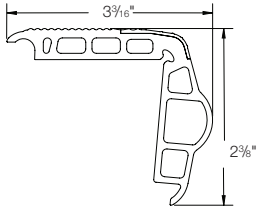

Bullnose Extrusion
BNS-TT-GY-12
 TwoTone Bullnose, 12' length, Black/Gray Strip
BNS-TT2-GY-12
 TwoTone Bullnose, 12' length, Black/2" Gray Strip
BNS-SC-GY-12
 Bullnose, Solid Gray, 12' Length

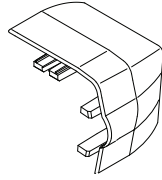

Bullnose End Caps
BNS-TT-EC-L
 End Cap, Left Side Overlap Design, Black
BNS-TT-EC-R
 End Cap, Right Side Overlap Design, Black

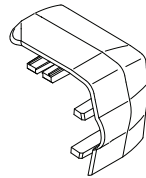

CC Bullnose End Caps (Carpet-To-Carpet)
BNS-CC-TT-EC-L
 End Cap, Carpet-To-Carpet, Left Side, Black
BNS-CC-TT-EC-R
 End Cap, Carpet-To-Carpet, Right, Black

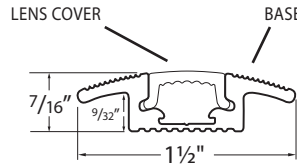

CC & CW Wire Way Combo - Base & Lens
WW-CC-BK-8
 Carpet to Carpet Base and Cover 8' - Black
WW-CC-GY-8
 Carpet to Carpet Base and Cover 8' - Gray
WW-CW-BK-8
 Carpet to Wall Base and Cover 8' - Black
WW-CW-GY-8
 Carpet to Wall Base and Cover 8' - Gray

CC & CW Wire Way Base ONLY
WW-CW-BS-8
 Base Only, Carpet to Wall, Black, 8'
WW-CC-BS-8
 Base Only, Carpet to Carpet, Black, 8'

CC & CW Wire Way Lens ONLY
WW-TC-CL-8
 Lens Cover Only, Clear, 8'
WW-TC-BK-8
 Lens Cover Only, Black, 8'
WW-TC-BZ-8
 Lens Cover Only, Bronze, 8'
WW-TC-GY-8
 Lens Cover Only, Gray, 8'

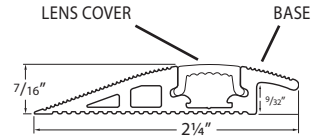

CE Wire Way Combo - Base & Lens
WW-CE-BK-8
 Carpet to Edge Base and Cover 8' - Black
WW-CE-GY-8
 Carpet to Edge Base and Cover 8' - Gray

CE Wire Way Base ONLY
WW-CE-BS-8
 Base Only, Carpet To Edge, Black, 8'

CE Wire Way Lens ONLY
WW-TC-CL-8
 Lens Cover Only, Clear, 8'
WW-TC-BK-8
 Lens Cover Only, Black, 8'
WW-TC-BZ-8
 Lens Cover Only, Bronze, 8'
WW-TC-GY-8
 Lens Cover Only, Gray, 8'

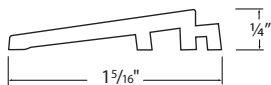

BNS-TT-R-12
 Step Reducer, 12' Section

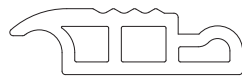

STP-EXTNDR-12
 Bullnose Step Landing Tread Extender, 12'



ADH-MB-75AM-10
 Extrusion adhesive, 10.1 oz tubes, sold individually. 30 per case.
ADH-MB-75AM-29
 Extrusion adhesive, 29 oz tubes, sold individually. 12 per case.



ADH-IA-10.2-CA
 End Cap Adhesive, Clear liquid adhesive for end caps. 10.2 oz tubes sold individually. 12 per case.

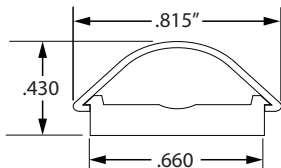

BS-CC-8
 Wall wireway, 8' Black Base & Conduit Cover

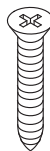

TM-3/16
 Concrete Screw 3/16" x 1 3/4"

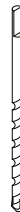

RONDB-5/32
 Concrete Drill Bit 5/32"